

G.T.trading reserves the right to make modifications or improvements to the products illustrated without notice thereof - The availability of the products illustrated is subject to change - The products described in this User's Guide represent just a part of the STEG products available - All brands and trademarks mentioned have been used exclusively for description purposes and all rights belong to the respective owners - Total or partial reproduction of this User's Guide is prohibited.

ST

COMPETITION AMPLIFIERS

ST401

ST402

USER'S GUIDE
Four-channel car audio power amplifier



STEC®

INTRODUCTION

GTtrading thanks you for your purchase, and would like to congratulate you on choosing an STEG product.

Kcompetition amplifiers guarantee superior performance levels in terms of electrics, mechanics and sound, keeping the characteristics stated constant through time. GTtrading wishes you happy listening.

The User's Guide

The user's guide was devised to facilitate the correct installation procedure so that you get the most out of your new amplifier. It contains information and vital procedures for the correct operation of the product and any devices connected to it.

The "Safety Measures General Rules" manual should be considered an integral part of this document. It is essential that all recommendations are observed in order to guarantee the safety of those responsible for installing and/or using the product.

Safety

The manuals contain information that is useful for installing and tuning the product. Nevertheless, it is recommended that these operations be performed by qualified persons only.

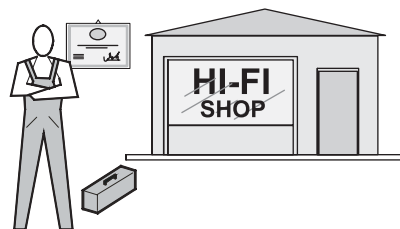
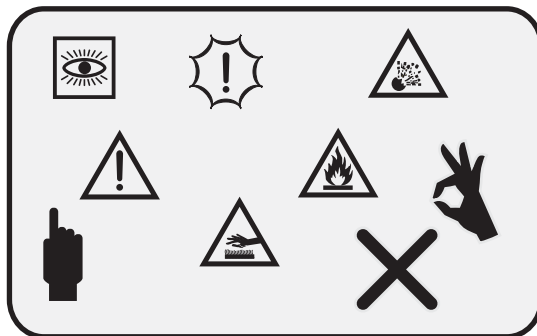
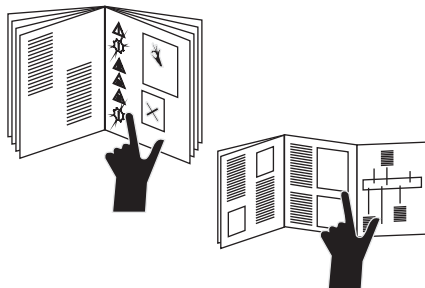

CONTENTS

INTRODUCTION	1
PRODUCT DESCRIPTION	3
Packaging and contents	4
General description	4
Input	4
Crossovers	4
Output	5
Power supply	5
TECH. SPECIFICATIONS	6
MEAS. CONDITIONS	6
BLOCK DIAGRAM	7
DIMENSIONS	7
FASTENING	7
CONTROL PANEL	
Power supply/more funct.	8-10
Speaker	11
CONNECTIONS	
Power supply	12
Speaker	13
Output load impedance	14
Passive filters	14
ADJUSTMENTS, USE	
First usage	15
Indicator LEDs	15
Sensitivity adjustment	16
CONFIGURATIONS	
Suggestions	17-20
MAINTENANCE	
Fuse replacement	21
After-sales Service	21
A.T.R.I.	21
Product identification	21
TROUBLESHOOTING	22
DIAGRAMS	23

PRODUCT DESCRIPTION

Packaging and contents

Kcompetition amplifiers are packed in a box designed to protect its contents. Do not damage or discard the packaging, but keep it for future use.

On receipt of the amplifier, check that:

the packaging is intact, the contents correspond to the specifications, the product has not been damaged in any way. In the event of missing parts, damages or other faults, report the latter to the Retailer you purchased it from immediately, making a note of the model and serial number of the amplifier.

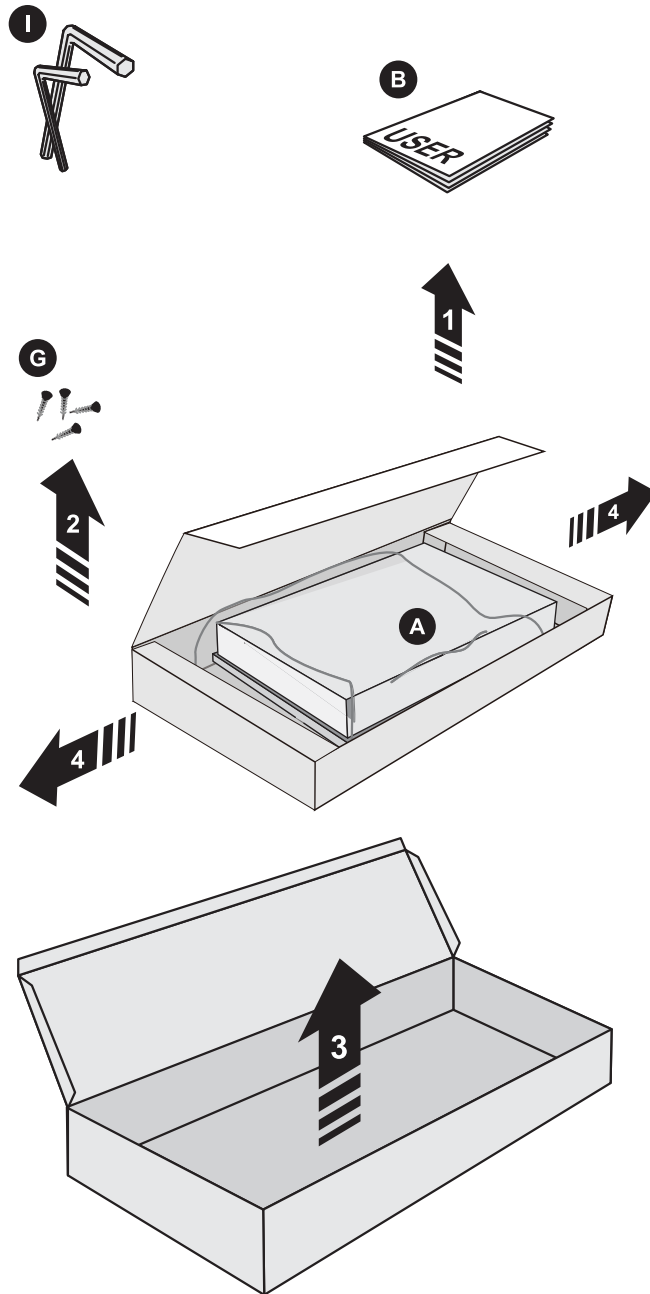

- A: Amplifier
ST401
ST402
- B: User's guide
- C: Spare fuses
ST401 (35Ax2)
ST402 (40Ax2)
- D: Fastening screws
(4) 3,9x19mm
- E: Exagonal wrenches
(2)
- F: FastOn connector
(2)

PRODUCT DESCRIPTION

General description

Kcompetition are stereo audio power amplifiers for car use, designed to amplify the signals reproduced by sources such as: tuners, cassette players, CD players, etc.

Input

The amplifier is divided up into two sections, "HIGH INPUT" and "LOW INPUT", which both feature a stereophonic input "LEFT(CH1/CH3)" and "RIGHT(CH2/CH4)", for the connection of the signal generated by the source or any elaboration devices fitted.

Crossovers

The amplifier features filter devices that can limit the output frequency band. The various settings allow you to optimize the signal in order to drive different speaker models.

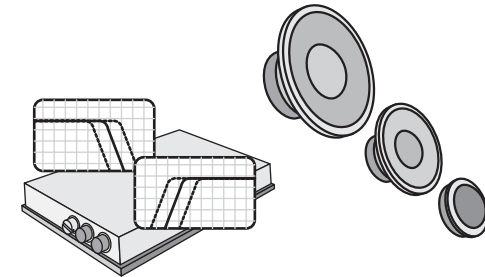
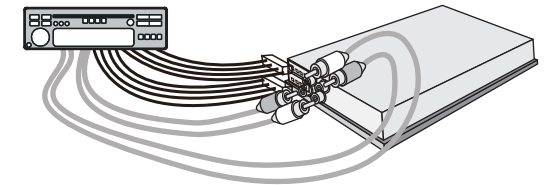
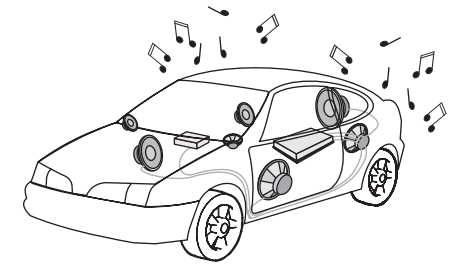

PRODUCT DESCRIPTION

Output

The loudspeaker system has to be connected to the terminals “+” and “-” of “**LEFT(CH1/CH3)**” and “**RIGHT(CH2/CH4)**” power outputs of two sections, “**CH1/CH2**” and “**CH3/CH4**”. According to the connections, the three basic configurations are obtained:

STEREO

BRIDGED MONO

TRIMODE

Power supply

The POSITIVE cable of the battery, the EARTH cable and the REMOTE cable that allows for switch-on to be synchronised with the source are all connected to the power supply section of the amplifier.

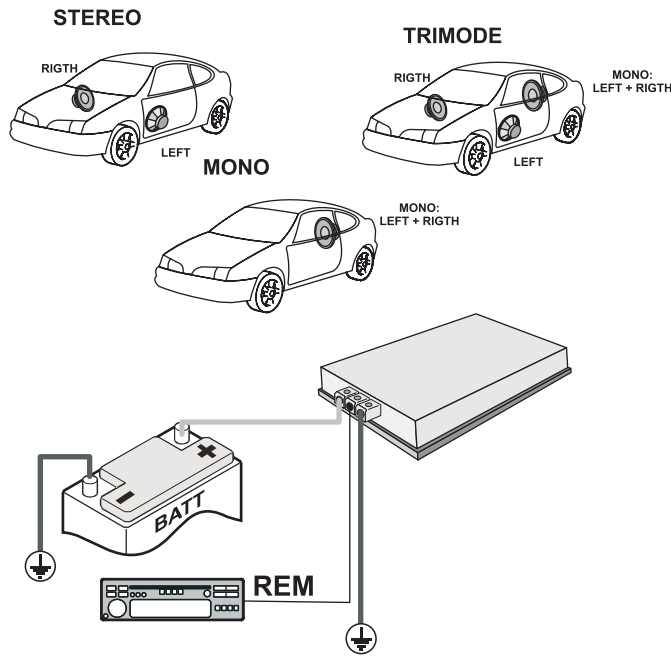
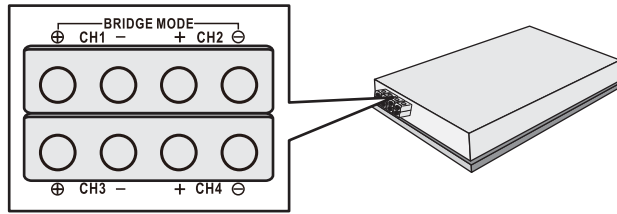

PRODUCT DESCRIPTION

SPECIFICATIONS

		ST401	ST402
RMS power @4ohm CEA Standard CEA-2006-A	Watt	90 x 4	120 x 4
RMS power @2ohm CEA Standard CEA-2006-A	Watt	130 x 4	190 x 4
RMS power @4ohm bridged CEA Standard CEA-2006-A	Watt	260 x 2	380 x 2
Damping factor	-	>100	>100
Signal to noise Ratio	dB	>88	>88
Input sensitivity range	V	0,5 9,0	0,5 9,0
Lowpass	Hz	50 4000	50 4000
Highpass	Hz	15 500	15 500
Bandpass	Hz	15 4000	15 4000
Bass boost	dB	0 +12(45Hz) (CH3&4)	0 +12 (45Hz) (CH3&4)
THD distortion	%	<0,09	<0,09
Frequency response -3dB	Hz	5 38000	5 38000
Fuses	A	35 x 2	40 x 2
Weight	Kg	3,41	4,21

MEASUREMENT CONDITIONS

(Unless otherwise specified). Voltage: 14,4 Volt | Temperature: 25°C | THD: 0,3% | Tolerance: ±5% | Load type: Pure resistive

	ST401	ST402
POWER RATING Watts per channel @ 4 Ohms <1% THD+N	90 x 4	125 x 4

PRODUCT DESCRIPTION

BLOCKS DIAGRAMS

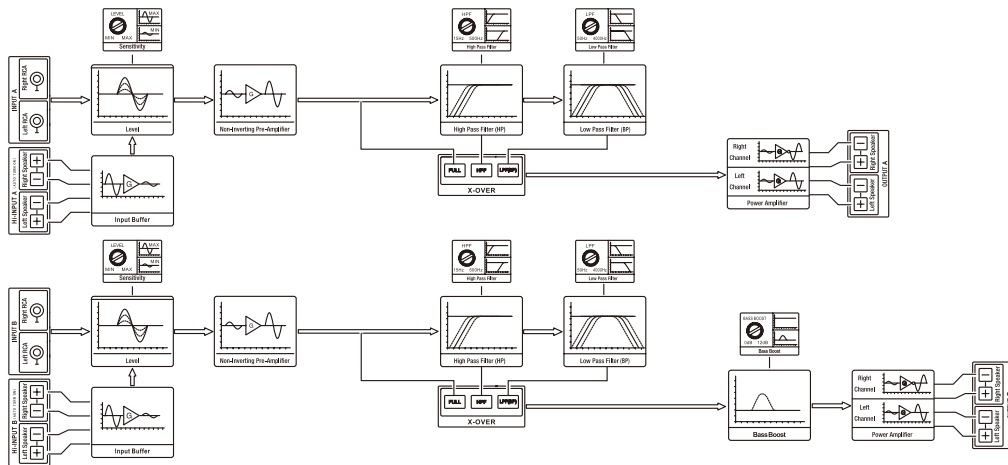

DIMENSIONS

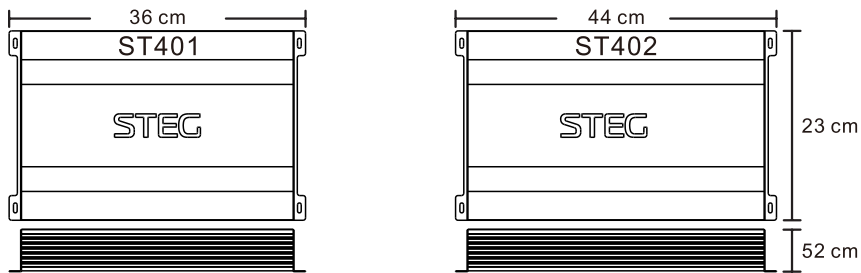

FASTENING

Fasten the feet securely to the amplifier and the amplifier to a surface designed to withstand its stresses, using all four slots foreseen. Tighten the fastening screws.



DAMAGE TO THE CAR COULD SERIOUSLY COMPROMISE THE SAFETY OF THE VEHICLE AND ITS PASSENGERS

CONTROL PANEL

Power supply/more functions

Speaker terminals
For connection of the speakers

1

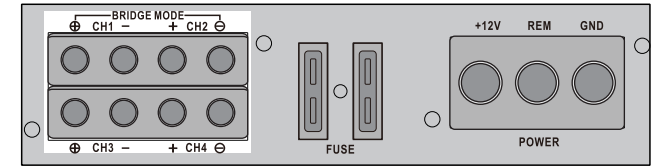

Power terminals

GND -> Ground connection
 REM -> Remote antenna terminal
 BATT -> +12 Volt

2

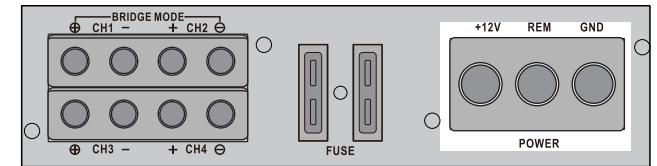

Status indication

GREEN - OK
 RED - Error

3

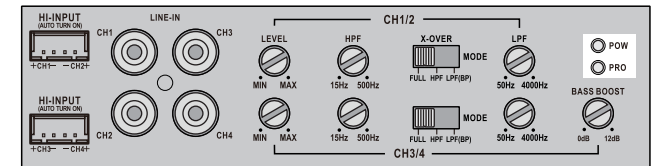

Cinch inputs

Terminal for connection of the RCA wires.
 To avoid failure, please use high quality RCA wires.

4

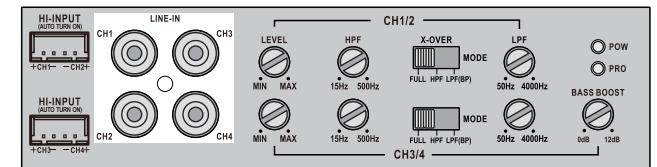

Input level controller

With this controller you can adjust the input sensitivity.

5

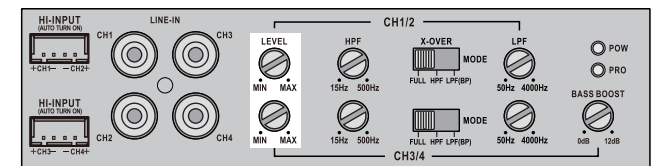

CONTROL PANEL

Power supply/more functions

Bass boost controller

For adjusting of the bass boost level in the range from 0 to +12 dB.

6

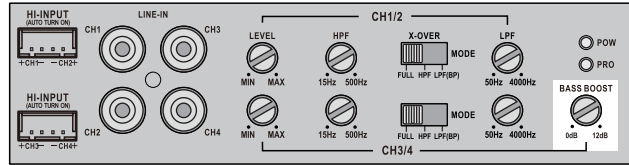

Mode switch

Adjust the crossover for the chosen utilization.

7

LPF – Only bass frequencies (below 50Hz -4000Hz) will be reproduced.
FULL – All frequencies will be reproduced.
HPF – Only middle and high frequencies (over 15Hz – 500Hz) will be reproduced.

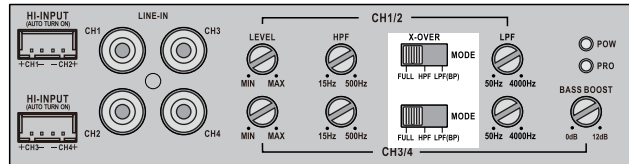

At LPF adjustment, also the Highpass (Subsonic) is activated. This equals a Bandpass filter of 15 – 4000Hz.

High pass controller (Subsonic)

Set the filter switch to "HIGH" position. Adjust the variable HPF crossover frequency to the desired frequency using the controller. All frequency between 15 and 500Hz will be reproduced.

8

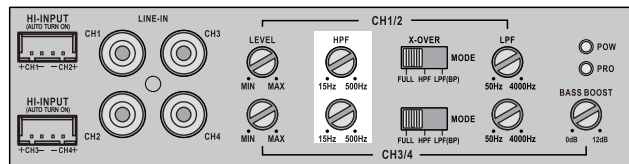

CONTROL PANEL

Power supply/more functions

Low pass controller

For subwoofer and Kickwoofer operation - Only frequencies from 50Hz to 4000Hz will be reproduced (depending on the LPF filter controller position). Set the filter switch to „LOW“ position. Adjust the variable LPF frequency to the desired frequency using the controller.

10

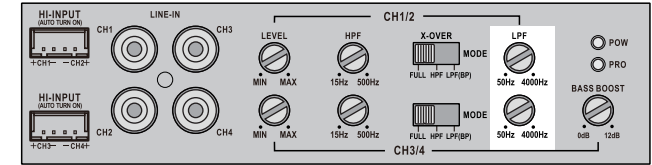

At LPF adjustment, also the Highpass (Subsonic) is activated. This equals a Bandpass filter of 15 – 4000Hz.

High Level inputs

These inputs must be used if your head unit is not equipped with a Low Level Cinch output. Connect this input to the speaker outputs of your head unit. The amplifier automatically turns on as soon as a signal is received (Auto On). The remote connection of the Power- Terminal (2) won't be used.

11

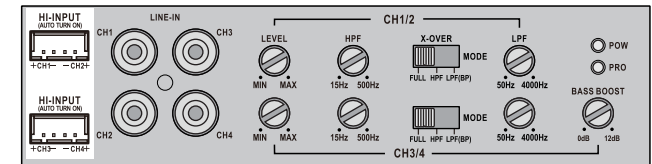

IMPORTANT!

Do not use the High level inputs and the Cinch inputs parallel, this can damage the amplifier. Use either the Cinch OR the High Level inputs.

CONTROL PANEL

Speaker

Connection the speaker system **1**

Speaker impedance for stereo connection is 2-8 Ohm and 4-8 Ohm for bridged mode connection.

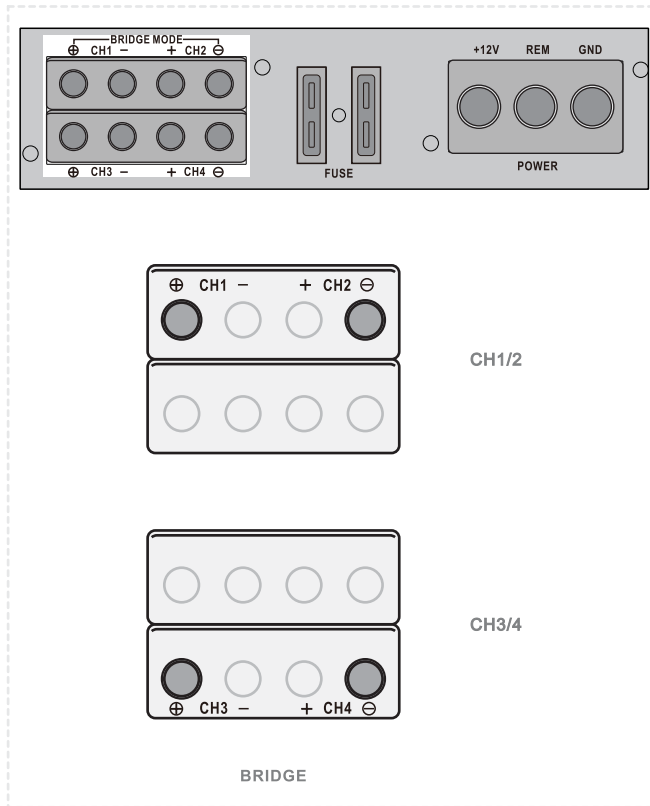

CONNECTIONS

The "Safety Measures General Rules" manual should be considered an integral part of this document. It is essential that all recommendations are observed in order to guarantee the safety of those responsible for installing and/or using the product.



Power supply

POSITIVE

Connect the "+12VDC" (4) terminal to the Positive pole of the battery via the external safety fuse.

NEGATIVE

Connect the "GROUND" (5) terminal firmly to a metal part of the vehicle free from any residue, using the shortest possible cable.

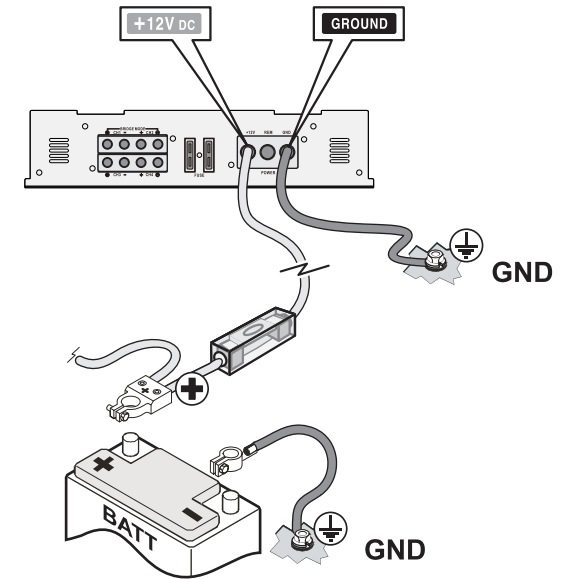

CONNECTIONS

Speaker

CONNECTING THE SPEAKER SYSTEM

1

Connect the speaker system to the speaker terminals (1). Depending on your configuration needs, perform the connection as follows:

A: STEREO

Loudspeakers connected in Stereophonic mode, on the right channel and on the left channel.

B: BRIDGED MONO

Loudspeakers connected in Monophonic mode taking the "bridged" signal from both channels.

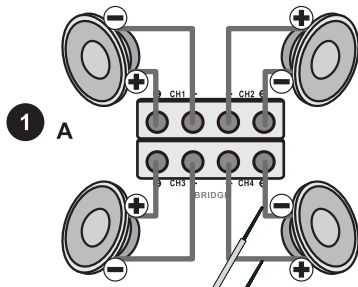
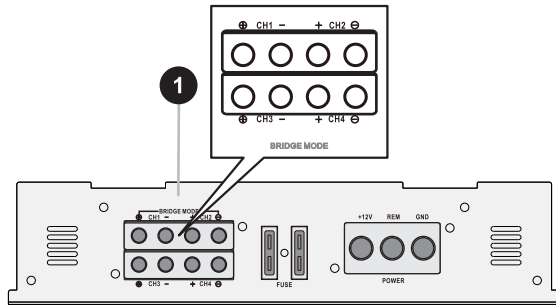

2 OHM MIN.

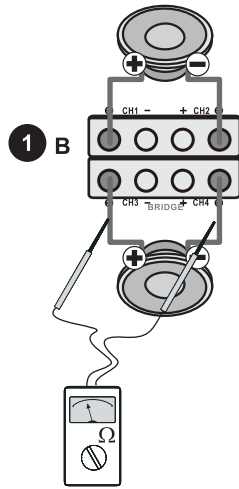

4 OHM MIN.

C: TRIMODE

Loudspeakers connected in both Monophonic and Stereophonic mode.

Output load impedance

Systems composed of several loudspeakers can be connected, as long as the overall impedance is not less than **2 Ohm** in Stereo configuration or **4 Ohm** in bridge Mono configuration.

In Trimode mode, the overall impedances of both the Stereo and Mono systems should not be less than **4 Ohm**.

Passive filters

Normally, is necessary to optimise the response of the various loudspeakers, using Passive Filters fitted with Capacitors and Inductors for audio use. Opposite is a table to help you identify the values of the components required: **L** for Inductors and **C** for Capacitors.

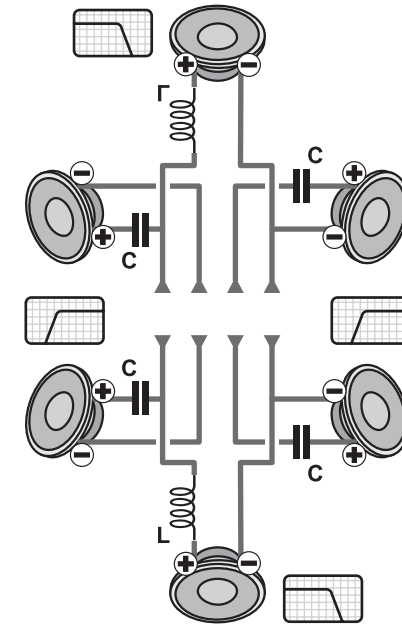
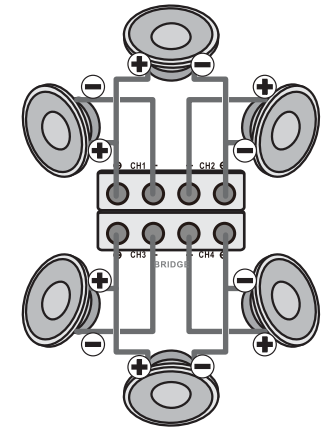

CUT F Hz	2 ohm		4 ohm	
	LmH	CµF	L mH	CµF
80	4.1	1000	8.2	500
100	3.1	800	6.2	400
130	2.4	600	4.7	300
200	1.6	400	3.3	200
260	1.2	300	2.4	150
400	.8	200	1.6	100
600	.5	136	1.0	68
800	.41	100	.82	50
1000	.31	78	.62	39
1200	.25	66	.51	33
1800	.16	44	.33	22
4000	.08	20	.16	10
6000	.051	14	.10	6.8
9000	.034	9.5	.068	4.7
12000	.025	6.6	.051	3.3

ADJUSTMENTS AND USE

First usage

BEFORE CONNECTING THE TERMINALS TO THE BATTERY, MAKE SURE THAT ALL CONNECTIONS HAVE BEEN MADE IN ACCORDANCE WITH THE GUIDES AND WITH THE RELEVANT DOCUMENTATION FOR THE DEVICES CONNECTED TO THE AMPLIFIER. SET VOLUME TO MINIMUM AND SWITCH-ON THE SOURCE.

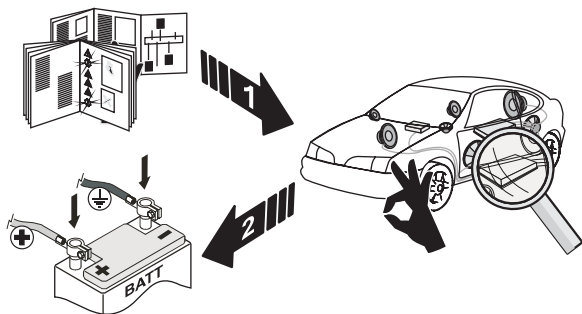

Indicator LEDs

The combinations of the green "POW" and red "PRO" warning lights indicate the operative status:

A Off

B On

Normal operation status.

C Overheating

Muting enforced due to overheating ($T > 90^{\circ}\text{C}$). The amplifier will resume as soon as the temperature returns below 70°C .

D Output short circuit

Muting enforced due to an output short-circuit or unacceptable low impedance load. The amplifier will resume correct operation as soon as normal output conditions are restored.

E GND ground fault

Muting enforced due to a GND circuit anomaly. The amplifier will resume as soon as the GND circuit returns to normal.

G Main fault

Serious malfunction, non-recoverable condition.

	POW	PRO		
A	○	○		
B	☀	○		
C	○	☀		
D	○	☀		
E	○	G	○	☀
G	○	☀		

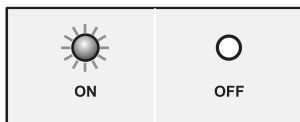

ADJUSTMENTS AND USE

Sensitivity adjustment

In order to harness all the power available, you must match the amplifier's sensitivity to the output voltage of the source, the value of which depends on both the constructional specifications and the level of the recording being played (CD, DVD, etc.). The manufacturer's indications refer to the reproduction of a signal recorded at maximum strength (0db); however, the majority of recordings on the market do not reach this level. This implies that, in general, the output voltage of the source is below the nominal value.

To set the sensitivity correctly, follow the procedure described below:

- Using a flat-tip screwdriver, turn the potentiometers anti-clockwise for the sensitivity (5), until you reach the end of the range.
- Turn the volume of the Source down to the minimum.
- Turn on the Source.
- Position the car radio volume to 3/4 of its range.
- Turn the sensitivity potentiometers (10/15) clockwise one by one until you hear the first signs of sound distortion.



The amplifier is ready to supply all the power!

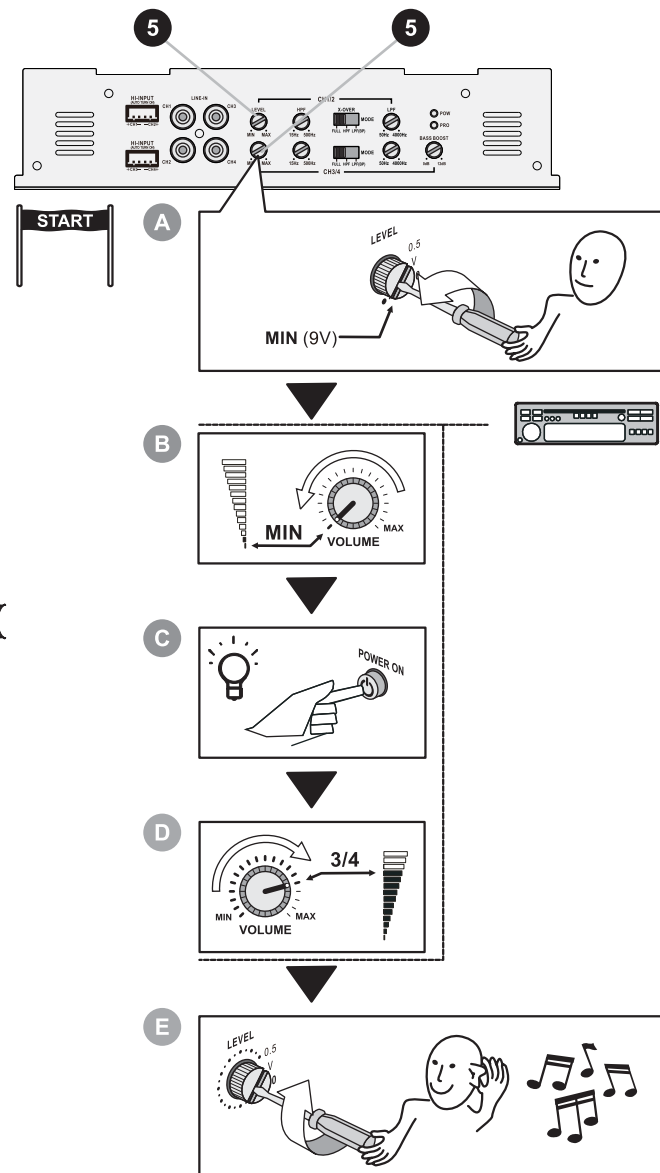

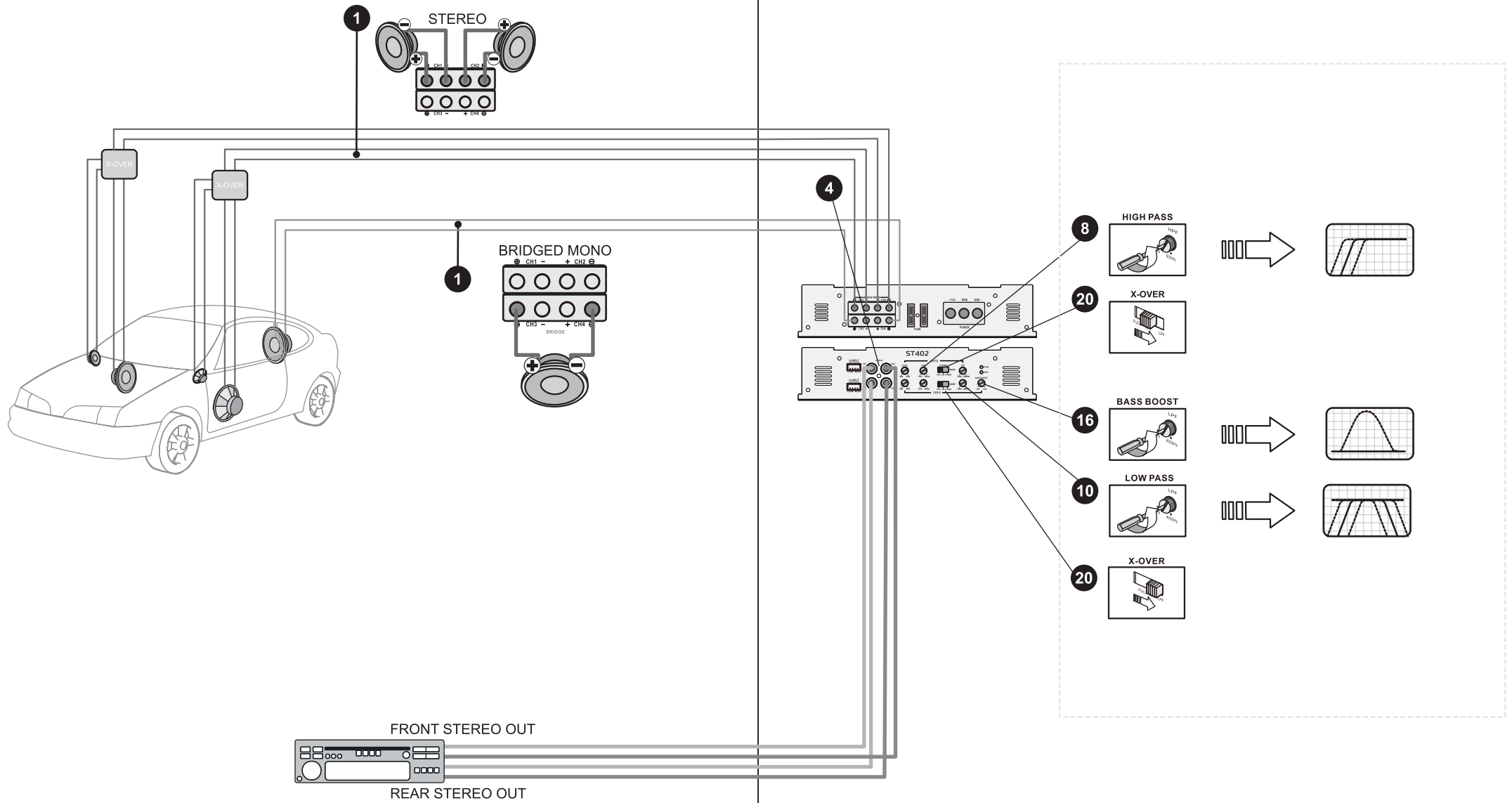

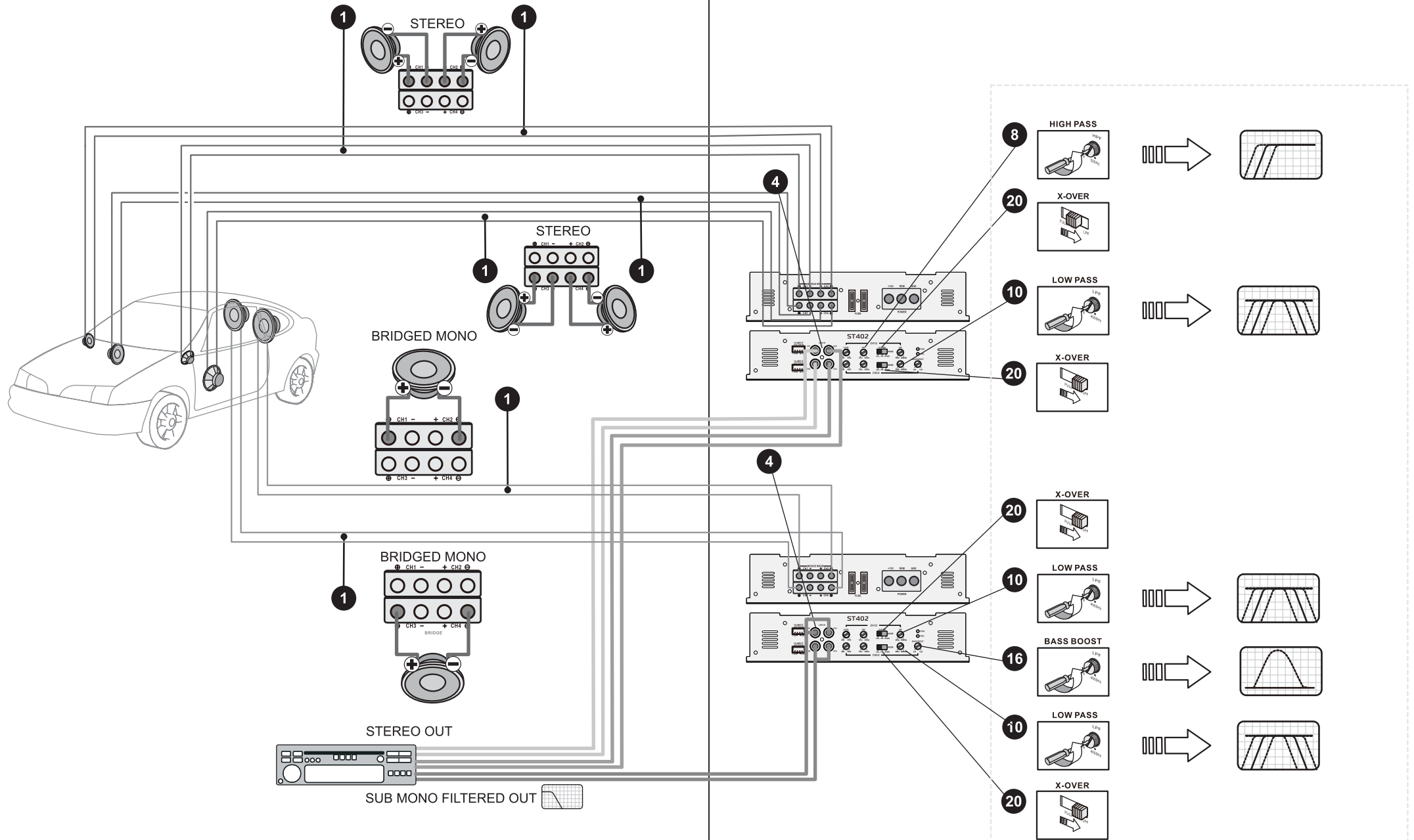

MAINTENANCE

Fuse replacement

Proceed with the fuse replacement making sure you have turned off the Source beforehand. Remove the burnt fuse and replace it with a new one of the same type and capacity (same maximum current).

After-sales service

For all After-Sales Service requirements, contact the Retailer you purchased the Amplifier from, to activate the A.T.R.I. procedure.

A.T.R.I.

The A.T.R.I. is a specialised centre in charge of all technical servicing and repair work in Italy. The service is offered by G.T.trading to guarantee top quality, rapid servicing for the best performance of all G.T.trading products at all times. Each product is analysed, repaired and tested exclusively in-house. Every product is automatically updated to the latest version through the replacement of all obsolete parts, including those not directly concerned by the repair.

Product identification

In all communications with G.T. Trading or authorised Retailers, always mention the model and serial number marked underneath the Amplifier.

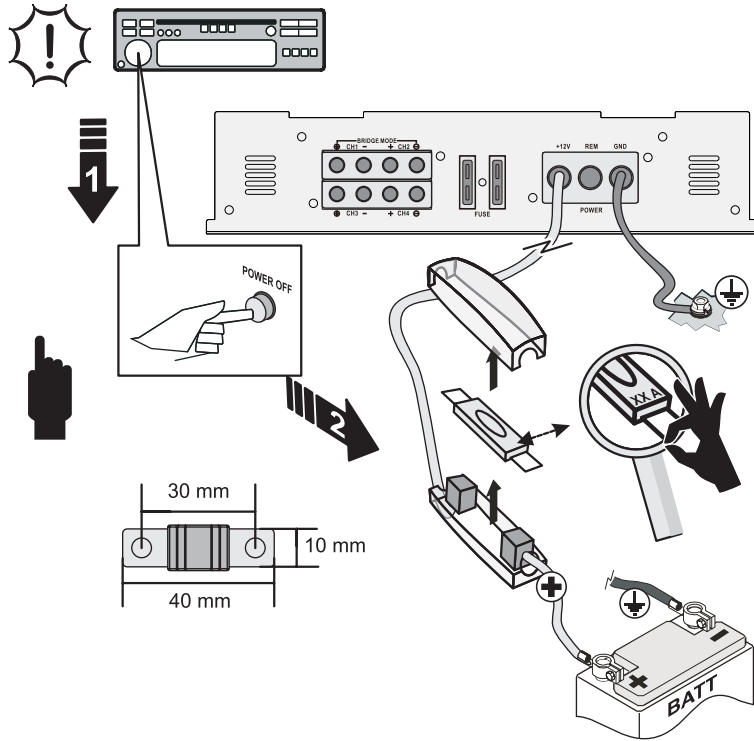

FAULTS AND TROUBLESHOOTING

ALL TROUBLESHOOTING OPERATIONS SHOULD BE CARRIED OUT BY A QUALIFIED TECHNICIAN ONLY WHO HAS READ AND UNDERSTOOD THE USER'S MANUAL IN FULL.



Source on, no sound, "POW" and "PRO" LEDs off or blinking.

FAULT:

1. There is no voltage on the "REM" terminal.
2. The Power supply circuit is unsuitable.
3. The fuse/s are burnt
4. The voltage at the power supply terminals of the amplifier is below 7 VDC.

REMEDY:

1. Check and reset the remote switch-on connection.
2. Check and reset the cable and the solidity of connections.
3. Replace the fuse(s) with (a) new one(s) of the same type and value.
4. Recharge the battery and check/reset the power supply circuit.

Source on, no sound, "POW" LED off and "PRO" LED on.

FAULT:

1. The amplifier has malfunctioned and the protection has been irreversibly activated.

REMEDY:

1. Contact your retailer to activate the Technical Service procedure.

